

# UniColor Series

24VDC IP67 RGB+CCT COB LED Tape



## UniColor Series

### 24VDC IP67 RGB+CCT COB LED Tape



#### Features

- RGB + CCT (2700K-6000K)
- Up to 220 lm/ft
- IP67 - rated for wet locations
- 2.2W max per foot with **Cyan / EnoSync** controllers (5.5W total all channels)
- Cuttable every 1.64"
- 3M adhesive backing
- Maximum run 32.8ft
- Available in 16ft and 100ft reels
- 6-year warranty



#### Specifications

<b>Input Voltage:</b>	24VDC
<b>Color Temperature:</b>	RGB + CCT (2700-6000K)
<b>CRI:</b>	90+
<b>Power:</b>	2.2W/ft.
<b>Lumens:</b>	Up to 220Lm/ft
<b>Cut Length:</b>	1.64" (41.67mm)
<b>Environment:</b>	IP20
<b>Dimensions (W x H x L):</b>	0.55" x 0.18" x 197"
<b>Maximum Run:</b>	32.8ft (74W)
<b>Beam Angle:</b>	150°
<b>Lamp Life:</b>	50,000
<b>Max Ambient Temperature:</b>	113°F
<b>Adhesive:</b>	3M

150° Beam Angle



#### Included Accessories

Ordering Code	Contains
Uni-IP67-TC-KIT	Uni-IP67-6P-TT-12 - 1pc Uni-IP67-6P-TW-6W - 1pc

#### Connectors and Wire

Ordering Code	Description
1) Uni-IP67-6P-TW-72W-12	Tape-to-wire connector with 72" wire
2) Uni-IP67-6P-TT-12	Tape-to-tape connector
3) Uni-IP67-6P-EC-12	End Cap
4) WS-IP67-6P-32	32ft, 6 Pin RGB+CCT Wire Spool

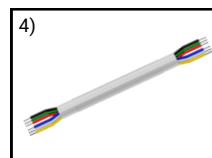
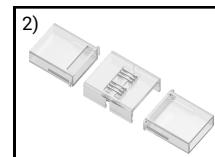
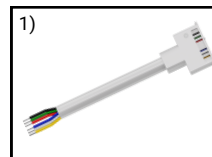

## UniColor Series

24VDC IP67 RGB+CCT COB LED Tape



### Performance Table

Ordering Code	Length	Max Run Length	Voltage	CCT	CRI	Wattage	Lumens	Cuttable	IP Rating
Uni-RGBCW-IP67-16	16.4ft	32.8ft	24VDC	RGB + CCT (2700-6000K)	90+	2.2W/ft.	Up to 220lm/ft	1.64" (41.67mm)	IP67
Uni-RGBCW-IP67-100	100ft	32.8ft	24VDC	RGB + CCT (2700-6000K)	90+	2.2W/ft.	Up to 220lm/ft	1.64" (41.67mm)	IP67

### Photometric and Power Data

LED Channel	Voltage	Watts/ft	Lumens	CCT	CRI	Wavelength
Warm White	24VDC	1.1W/ft.	110lm/ft	2700K	90+	-
Cool White	24VDC	1.1W/ft.	110lm/ft	6000K	90+	-
Red	24VDC	1.1W/ft.	-	-	-	630nm
Green	24VDC	1.1W/ft.	-	-	-	530nm
Blue	24VDC	1.1W/ft.	-	-	-	460nm

Total wattage for all channels on is 5.5W/ft max



## UniColor Series

24VDC IP67 RGB+CCT COB LED Tape



### Mechanical Diagrams

#### Uni-RGBCW-16

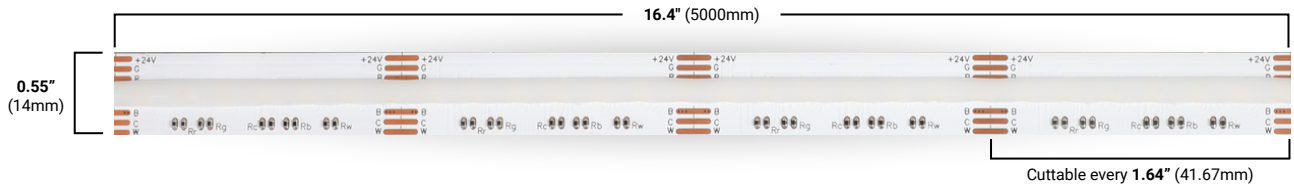

#### Connections

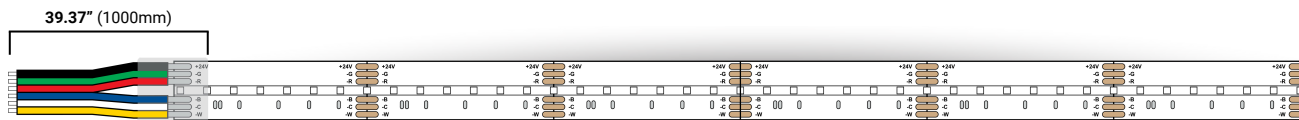

#### Uni-IP67-6P-TW-72W-12 (Tape-to-wire connector)

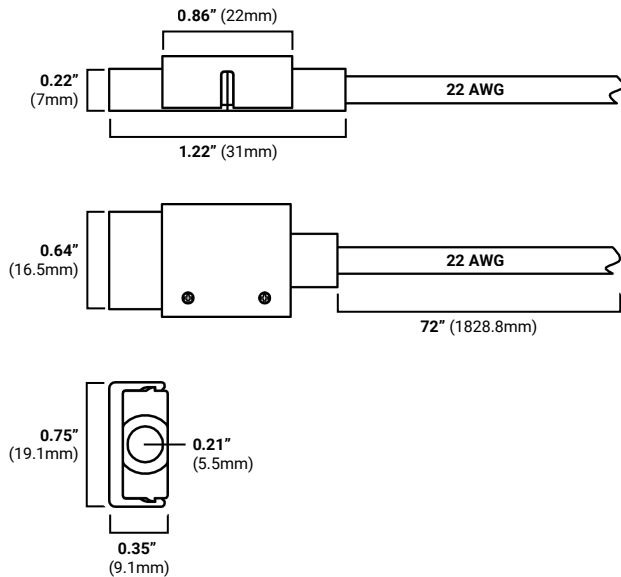

Sold separately, not included

#### Uni-IP67-6P-TT-12 (Tape-to-tape connector)

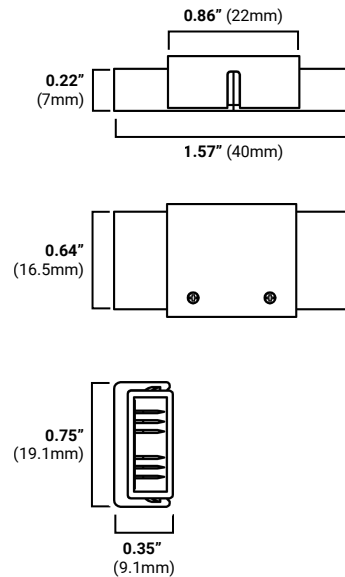

## UniColor COB

24VDC IP67 RGB+CCT COB LED Tape



### Compatible Controllers

Part Number	Description
EnoSnc-Hub5	Smart LED Controller

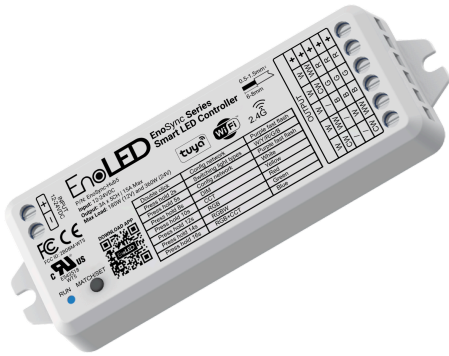

### User Interface

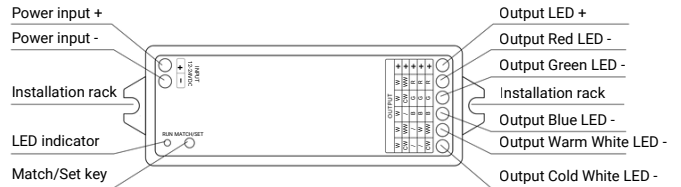

### Wiring Diagrams

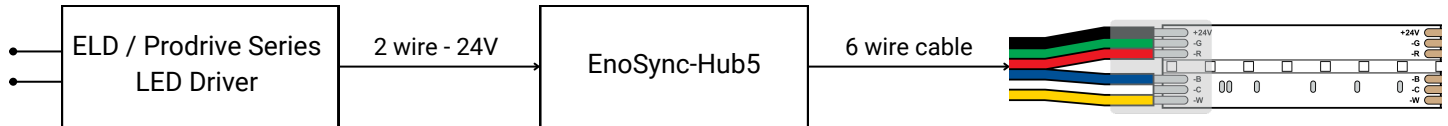

### Control Options

#### Smart Phone



#### Compatible Remotes



P/N: ES-RT-Z4-Dim



P/N: ES-RT-Z4-TW

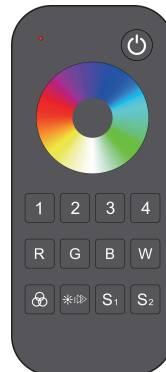

P/N: ES-RT-Z4-RGBW

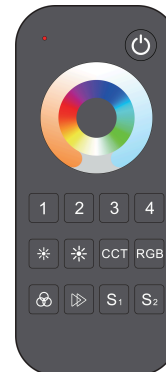

P/N: ES-RT-Z4-RGBCCT

## UniColor COB

24VDC IP67 RGB+CCT COB LED Tape



### Compatible Controllers

Part Number	Description
STCV-B-100W-C-RGBCW	Smart LED Controller

### User Interface

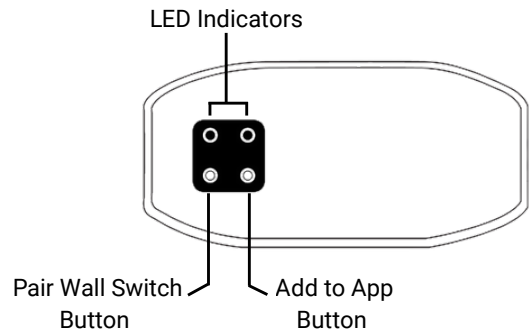

### Wiring Diagrams

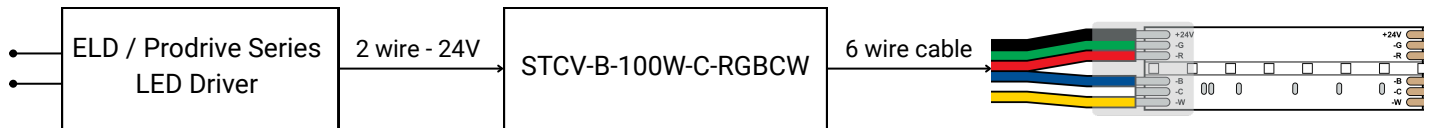

### Control Options

Smart Life App



Compatible CyanWallSwitch



P/N: CYAN-RGBCW-SW3



## UniColor COB

### 24VDC IP67 RGB+CCT COB LED Tape



### Recommended LED Drivers

#### ELD - IP65 Non-Dim Series - Plug-in Version



Ordering Code	Input Voltage	Output Voltage	Max Load	Class	Environment	Dimensions
ELD-100W-24VDC-UL-PLUG	120VAC	24VDC	100W	Yes	IP65	8" x 2.4" x 0.78"
ELD-200W-24VDC-UL-PLUG	120VAC	24VDC	200W	Yes	IP65	9.3" x 2.48" x 1.25"
ELD-300W-24VDC-UL-PLUG	120VAC	24VDC	300W	Yes	IP65	8.97" x 2.83" x 1.25"

#### ELD - IP65 Non-Dim Series - Direct Wire Version

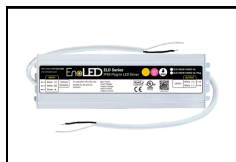

Ordering Code	Input Voltage	Output Voltage	Max Load	Class	Environment	Dimensions
ELD-100W-24VDC-UL	120VAC	24VDC	100W	Yes	IP65	8" x 2.4" x 0.78"
ELD-200W-24VDC-UL	120VAC	24VDC	200W	Yes	IP65	9.3" x 2.48" x 1.25"
ELD-300W-24VDC-UL	120VAC	24VDC	300W	Yes	IP65	8.97" x 2.83" x 1.25"

#### ProDrive Series - Low Profile 5-in-1 Dimmable Series



Ordering Code	Input Voltage	Output Voltage	Max Load	Class	Environment	Dimensions
ProDrive-40W-24DC	120-277VAC	24VDC	40W	Yes	IP21	6.29" x 2.28" x 0.78"
ProDrive-60W-24DC	120-277VAC	24VDC	60W	Yes	IP21	7.28" x 2.5" x 0.86"
ProDrive-96W-24DC	120-277VAC	24VDC	96W	Yes	IP21	7.28" x 2.5" x 0.86"

#### NanoDrive - 0-10V Dimmable Series



Ordering Code	Input Voltage	Output Voltage	Max Load	Class	Environment	Dimensions
NANO-40W-24VDC	120-277VAC	24VDC	40W	Yes	IP65	1.97" x 1.45" x 8.77"
NANO-60W-24VDC	120-277VAC	24VDC	60W	Yes	IP65	1.97" x 1.45" x 8.77"
NANO-96W-24VDC	120-277VAC	24VDC	96W	Yes	IP65	1.97" x 1.45" x 8.77"

# UniColor COB

## 24VDC IP67 RGB+CCT COB LED Tape



### Channel Compatibility

#### Surface Mount

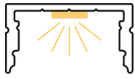

**SL-430-S-94**  
**Aluminium Finish**  
 Width (outside): 0.93" (23.50mm)  
 Width (inside): 0.80" (20.30mm)  
 Height: 0.50" (12.80mm)  
 Length: 94" (2.38m)

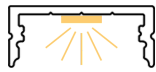

**SL-454-S-94**  
**Aluminium Finish**  
 Width (outside): 0.93" (23.50mm)  
 Width (inside): 0.80" (20.30mm)  
 Height: 0.39" (12.80mm)  
 Length: 94" (2.38m)

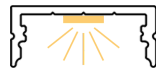

**SL-454-B-94**  
**Aluminium Finish**  
 Width (outside): 0.93" (23.50mm)  
 Width (inside): 0.80" (20.30mm)  
 Height: 0.39" (12.80mm)  
 Length: 94" (2.38m)



**SL-504-S-94**  
**Aluminium Finish**  
 Width (outside): 1.31" (33.20mm)  
 Width (inside): 1.18" (30.00mm)  
 Height: 0.57" (14.40mm)  
 Length: 94" (2.38m)

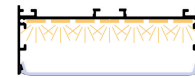

**SL-977-S-94**  
**Aluminium Finish**  
 Width (outside): 3.97" (100.90mm)  
 Width (inside): 3.60" (91.50mm)  
 Height: 1.48" (37.50mm)  
 Length: 94" (2.38m)

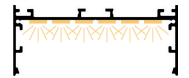

**SL-998-S-94**  
**Aluminium Finish**  
 Width (outside): 3.37" (85.50mm)  
 Width (inside): 3.00" (76.20mm)  
 Height: 1.43" (36.20mm)  
 Length: 94" (2.38m)

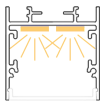

**SL-910-S-94**  
**Aluminium Finish**  
 Width (outside): 1.44" (36.70mm)  
 Width (inside): 1.18" (30.00mm)  
 Height: 1.44" (36.70mm)  
 Length: 94" (2.38m)

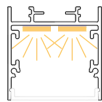

**SL-910-B-94**  
**Black Finish**  
 Width (outside): 1.44" (36.70mm)  
 Width (inside): 1.18" (30.00mm)  
 Height: 1.44" (36.70mm)  
 Length: 94" (2.38m)



**SL-928-S-94**  
**Aluminium Finish**  
 Width (outside): 1.97" (50.00mm)  
 Width (inside): 1.80" (45.72mm)  
 Height: 1.16" (29.50mm)  
 Length: 94" (2.38m)

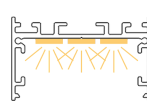

**SL-928-B-94**  
**Black Finish**  
 Width (outside): 1.97" (50.00mm)  
 Width (inside): 1.80" (45.72mm)  
 Height: 1.16" (29.50mm)  
 Length: 94" (2.38m)

#### Corner LED Channel



**SL-511-S-94**  
**Aluminium Finish**  
 Width (outside): 1.18" (30mm)  
 Width (inside): 0.83" (21mm)  
 Height: 1.18" (30mm)  
 Length: 94" (2.38m)

#### Recessed Mount

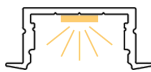

**RL-727-S-94**  
**Aluminium Finish**  
 Width (outside): 1.20" (30.60mm)  
 Width (inside): 0.80" (20.30mm)  
 Height: 0.50" (12.80mm)  
 Length: 94" (2.38m)



**RL-778-S-94**  
**Aluminium Finish**  
 Width (outside): 1.31" (33.20mm)  
 Width (inside): 1.18" (30.00mm)  
 Height: 0.57" (14.40mm)  
 Length: 94" (2.38m)

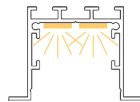

**RL-809-S-94**  
**Aluminium Finish**  
 Width (outside): 1.43" (36.30mm)  
 Width (inside): 1.30" (33.10mm)  
 Height: 1.38" (35.00mm)  
 Length: 94" (2.38m)



**RL-851-S-94**  
**Aluminium Finish**  
 Width (outside): 2.52" (64.00mm)  
 Width (inside): 1.57" (40.00mm)  
 Height: 1.16" (29.50mm)  
 Length: 94" (2.38m)

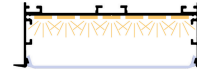

**RL-977-S-94**  
**Aluminium Finish**  
 Width (outside): 4.44" (112.8mm)  
 Width (inside): 3.60" (91.50mm)  
 Height: 1.48" (37.50mm)  
 Length: 94" (2.38m)

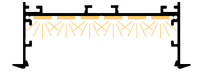

**RL-873-S-94**  
**Aluminium Finish**  
 Width (outside): 3.83" (97.40mm)  
 Width (inside): 3.00" (76.20mm)  
 Height: 1.43" (36.40mm)  
 Length: 94" (2.38m)

#### Trimless Mud-In



**TL-041-S-94**  
**Aluminium Finish**  
 Width (outside): 0.93" (23.50mm)  
 Width (inside): 0.80" (20.50mm)  
 Height: 0.61" (15.50mm)  
 Length: 94" (2.38m)



**TL-066-S-94**  
**Aluminium Finish**  
 Width (outside): 1.44" (36.70mm)  
 Width (inside): 1.18" (30.00mm)  
 Height: 0.61" (15.50mm)  
 Length: 94" (2.38m)



**TL-071-S-94**  
**Aluminium Finish**  
 Width (outside): 1.97" (50.00mm)  
 Width (inside): 1.77" (45.00mm)  
 Height: 0.61" (15.50mm)  
 Length: 94" (2.38m)